

V DANÉ AKONOMETRII ZOBRAZTE BODY O DANÝCH SOUŘADNICÍCH

- 1)  $B(5, 1, 0)$   
 $C(0, 3, 6)$   
 $D(-2, 0, 1)$   
 $E(0, 0, -3)$

- 2)  $F(0, 4, 0)$   
 $G(4, 0, 6)$   
 $H(0, 0, 2)$   
 $K(-4, -3, -5)$

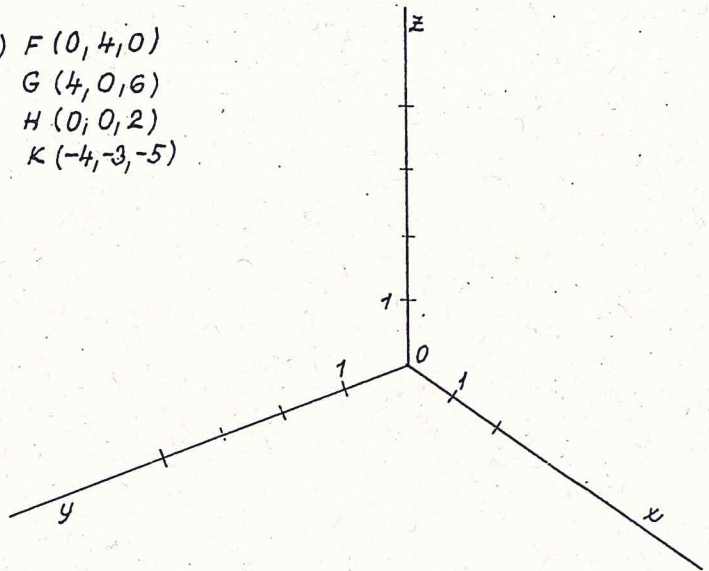
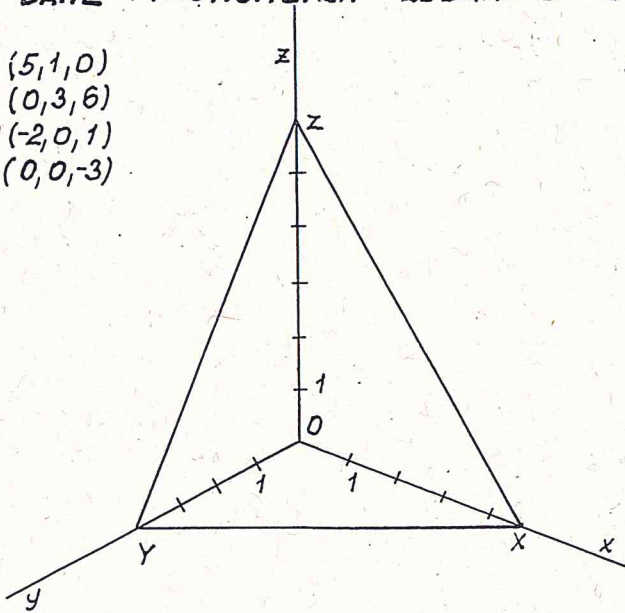

DOPLŇTE SCHÁZEJÍCÍ PRŮMĚTY DANÝCH BODŮ

3)

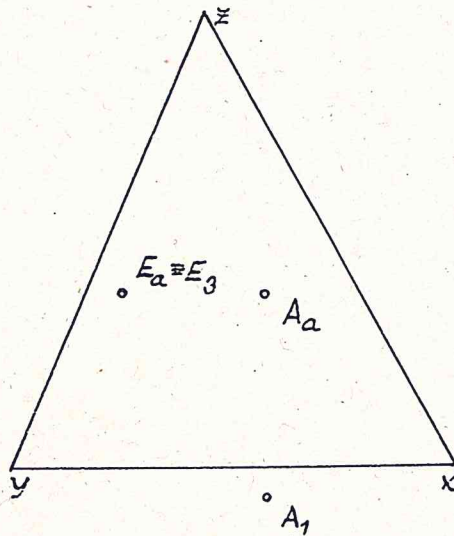

4)<sup>x</sup>

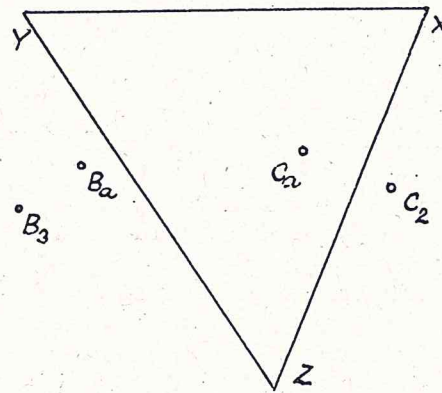

ZJISTĚTE SOUŘADNICE DANÉHO BODU M

5)

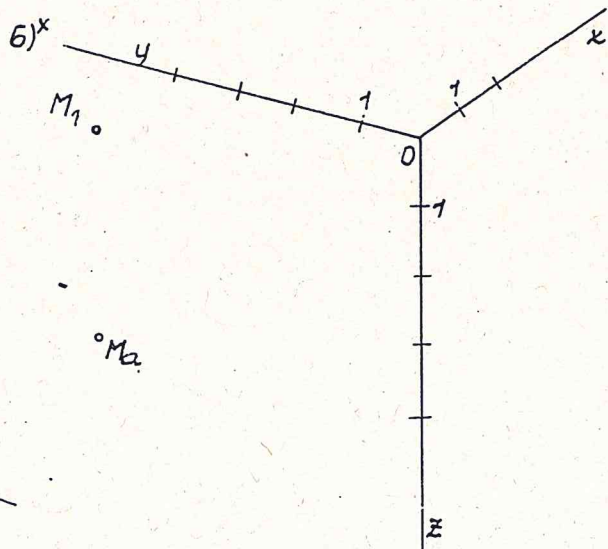
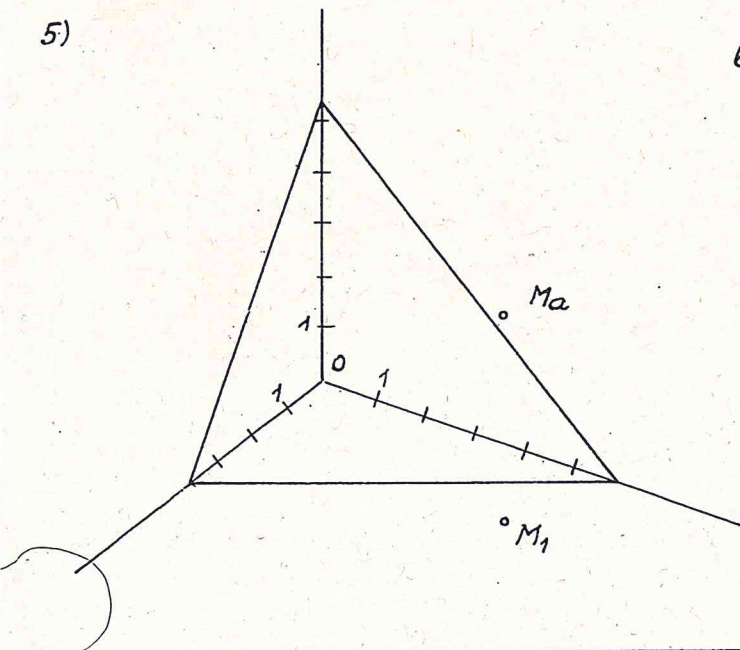

V DANÉ AXONOMETRII DOPLŇTE SCHÁZEJÍCÍ PRŮMĚTY PŘÍMKY  $p$   
 A SESTROJTE STOPNÍKY  $P, N, M$

1)

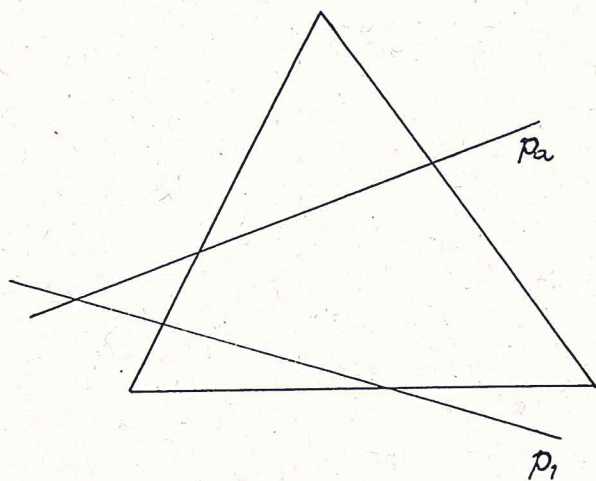

2)<sup>x</sup>

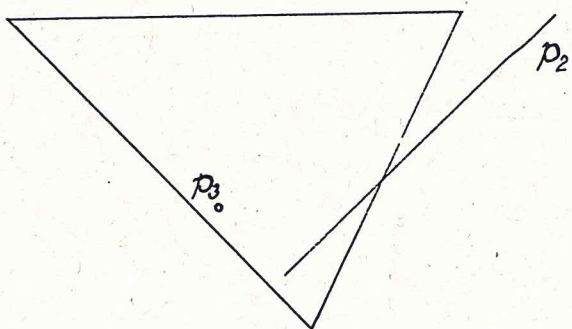

3)

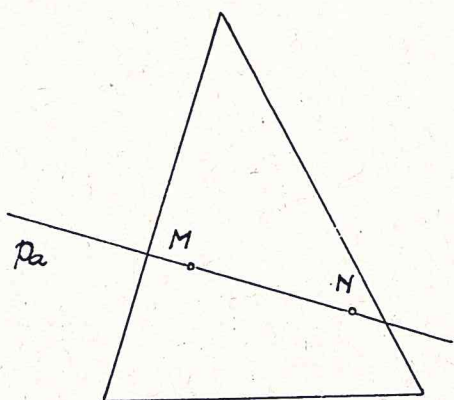

4)

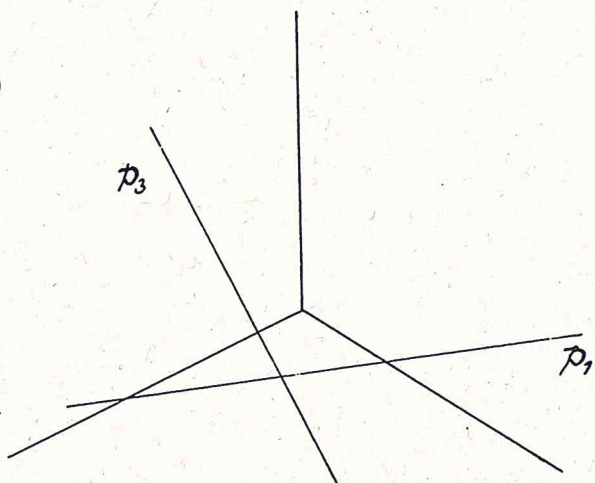

5)

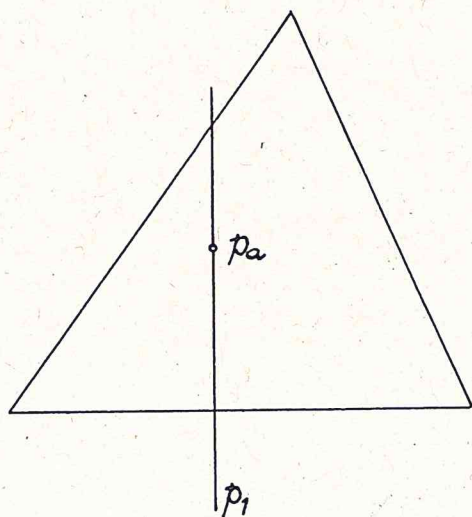

6)

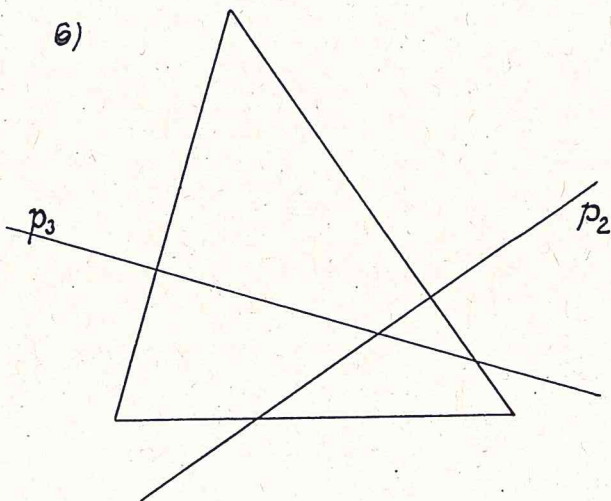

PŘÍMKA  $p$  LEŽÍ V ROVINĚ  $\alpha$ . DOPLŇTE SCHÁZEJÍCÍ OBRAZY PŘÍMKY  $p$

1)

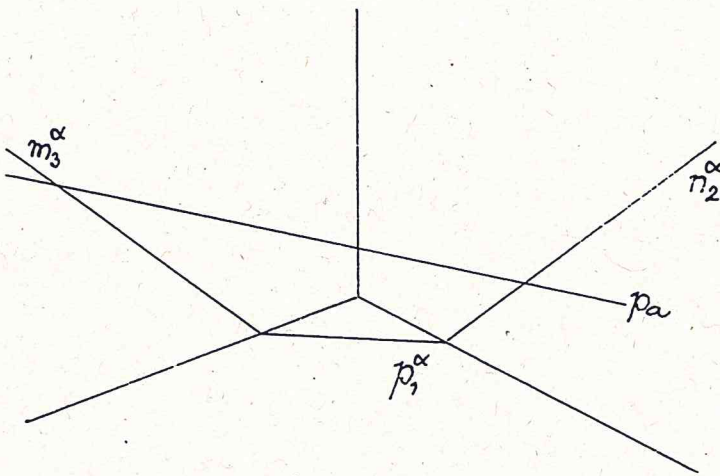

2)

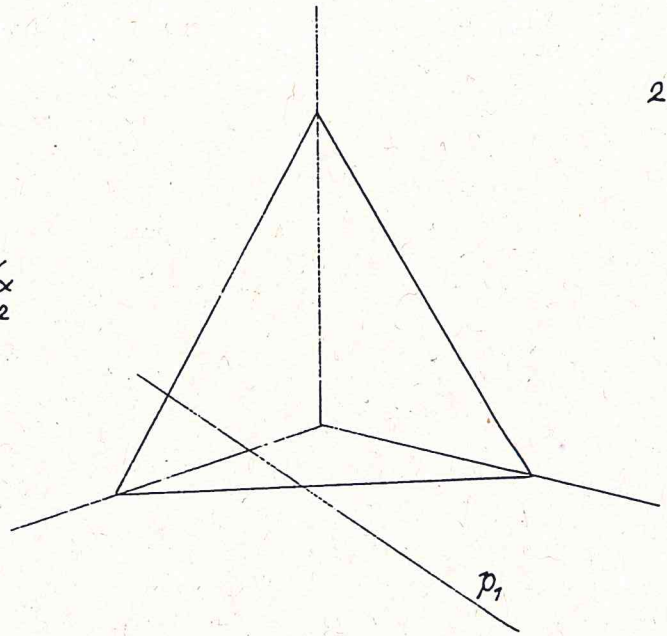

SESTROJTE STOPY ROVINY  $\alpha$

3)

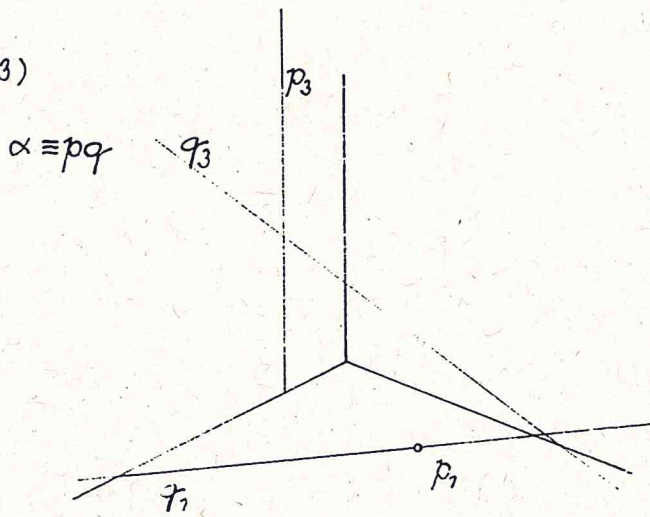

$C_{a_0}$

$C_{1_0}$

4) x

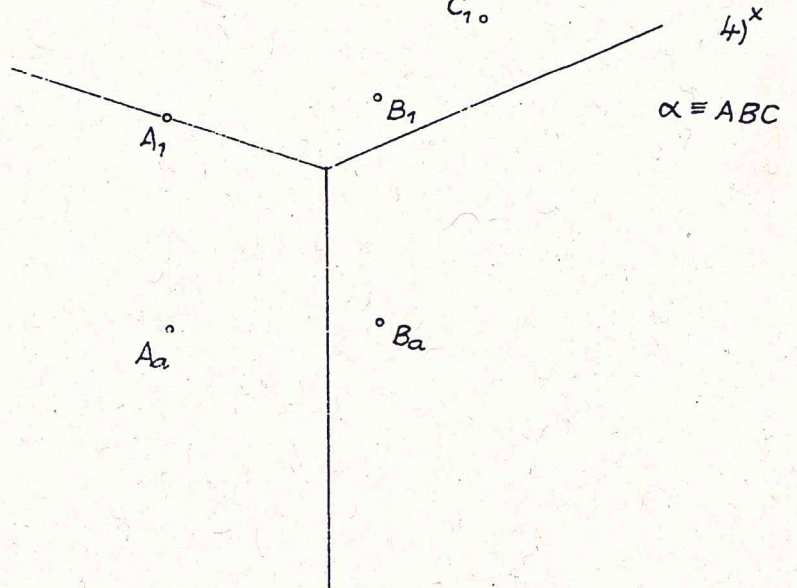

5)

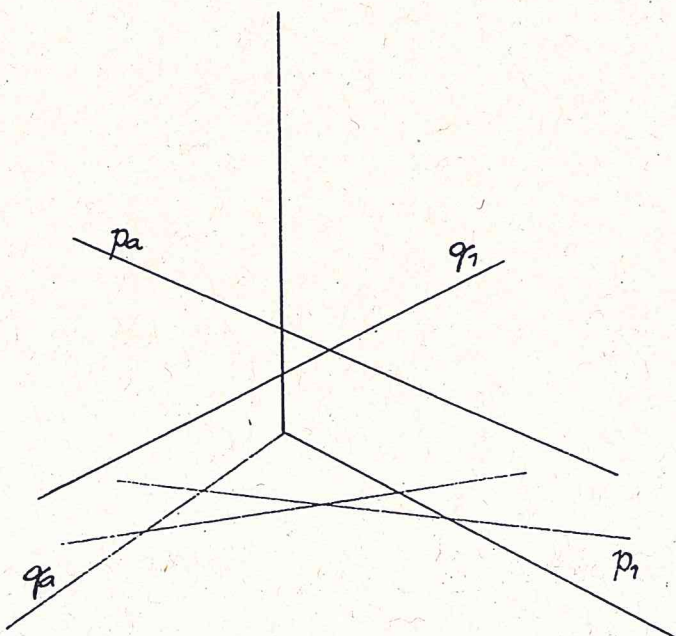

6)

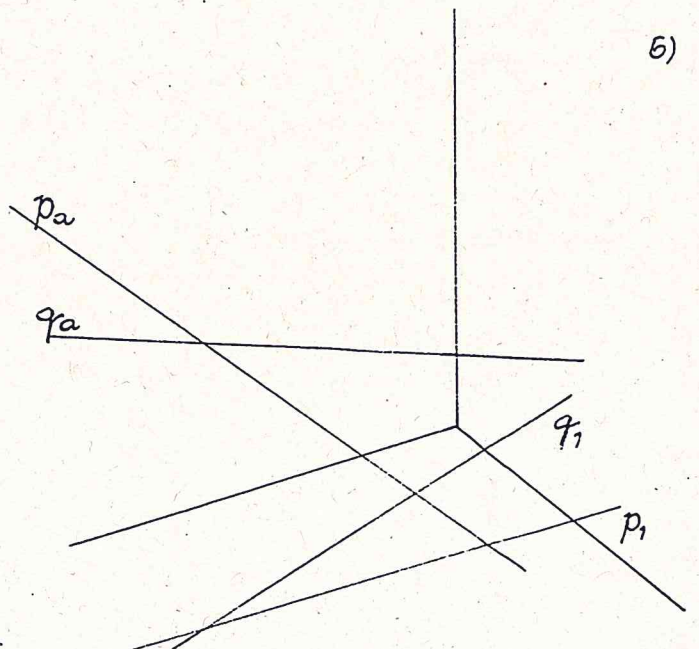

BOD A LEŽÍ V ROVINĚ  $\alpha$ . DOPLNTE SCHÁZEJÍCÍ PRŮMĚTY

1)

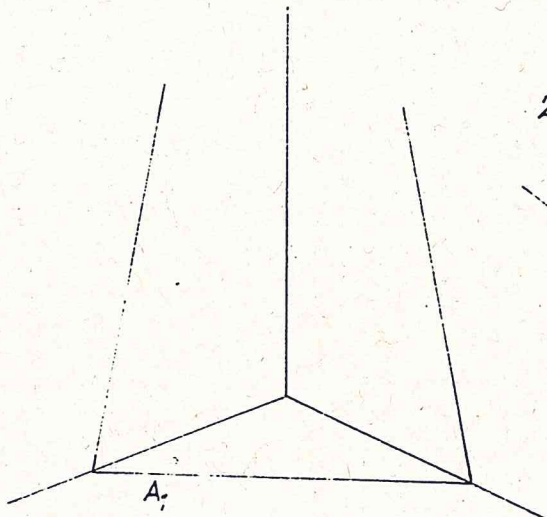

2)

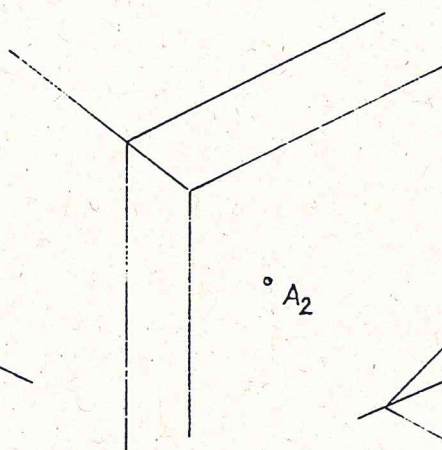

3)

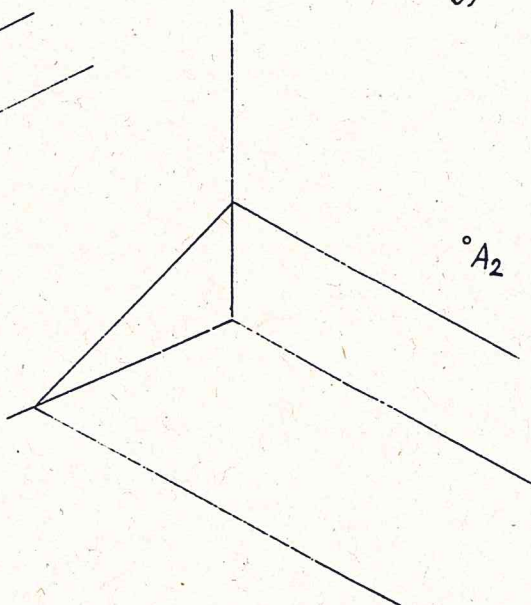

4)

$\alpha \equiv \rho$

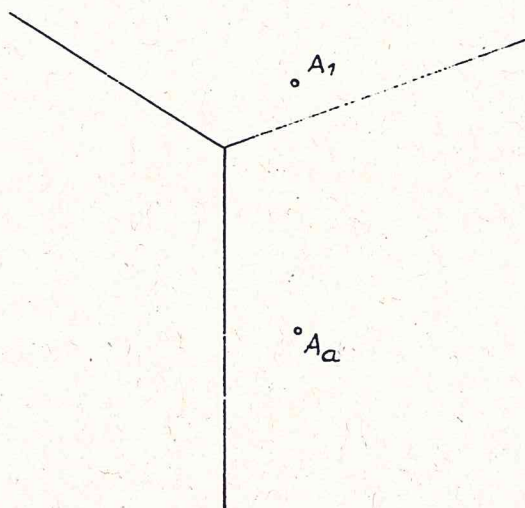

5)  $\alpha \equiv \rho$

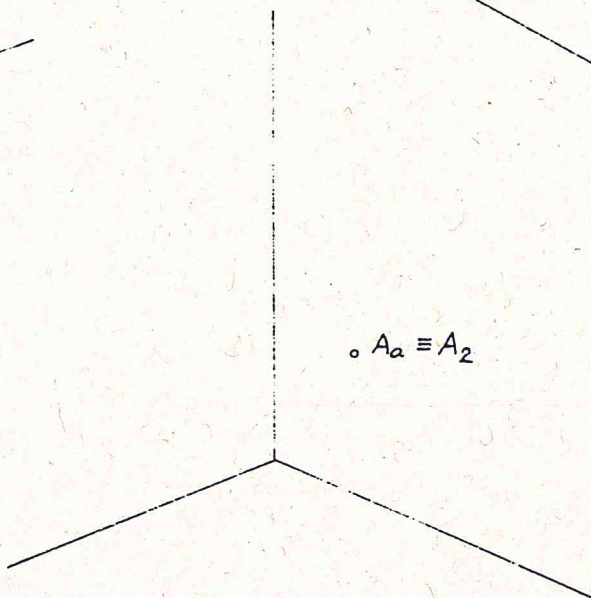

$\rho$ -AXONOMETRICKÁ PRŮMĚTNA

ROZHODNĚTE, JSOU-LI BOD H A ROVINA  $\alpha$  INCIDENTNÍ  
 PODTRHNĚTE SPRÁVNOU ODPOVĚĎ

6)

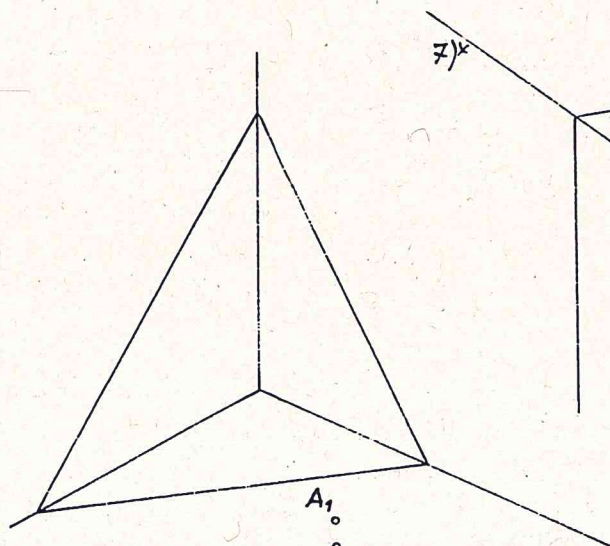

ANO	NE
-----	----

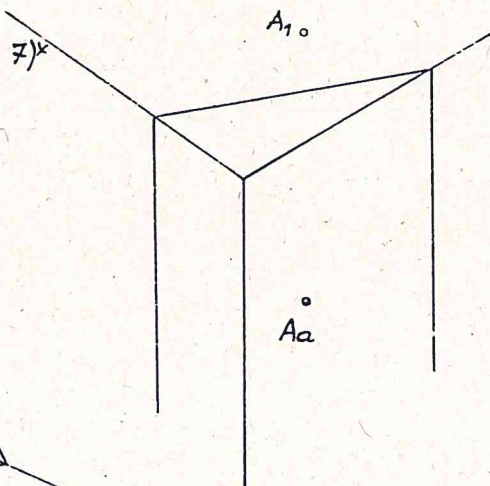

ANO	NE
-----	----

8)

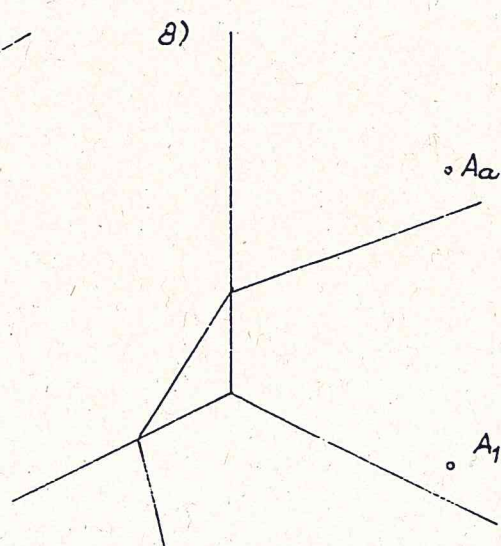

ANO	NE
-----	----

SESTAVTE IZOBRAŽENÉ PŘÍMÉTY A AXONOMETRICKÝ OBRAZ  
 PRŮSEČNICE DVOU ROVIN

1)

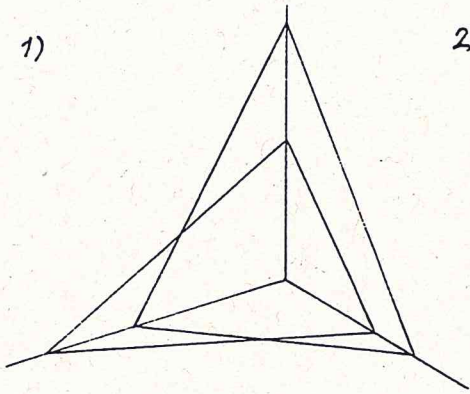

2)<sup>x</sup>

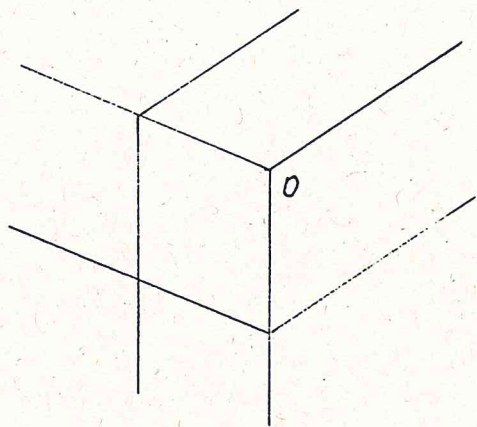

3)

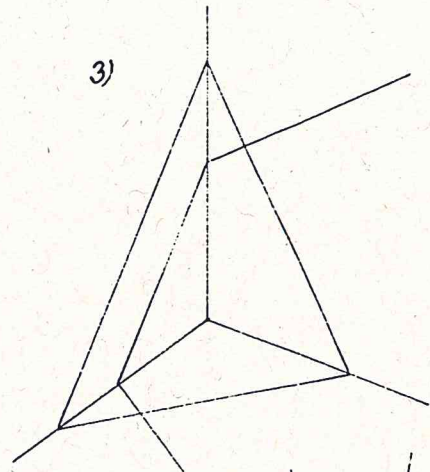

4)<sup>x</sup>

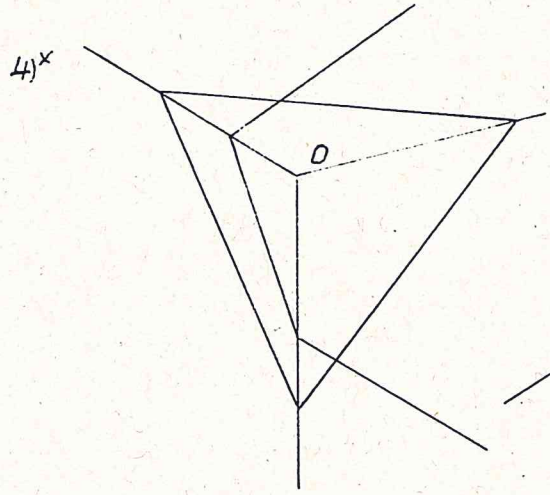

5)

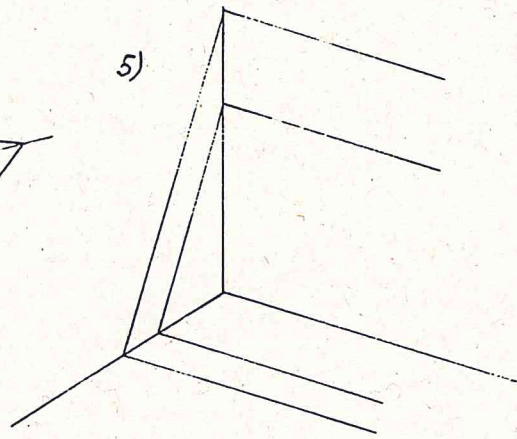

6)<sup>x</sup>

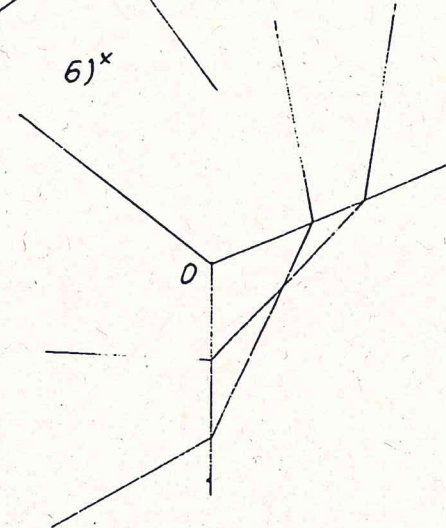

7)

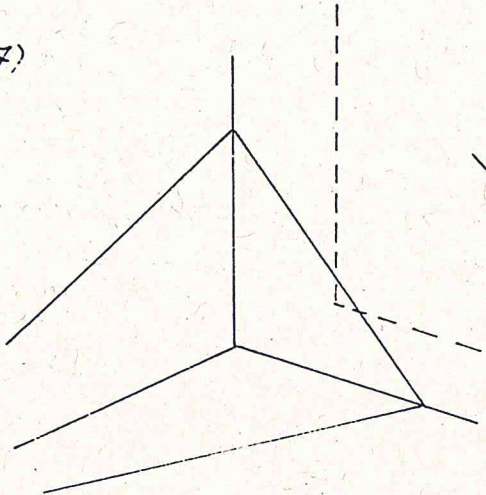

8)

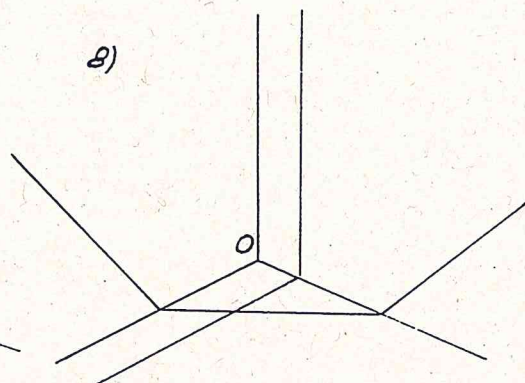

9)

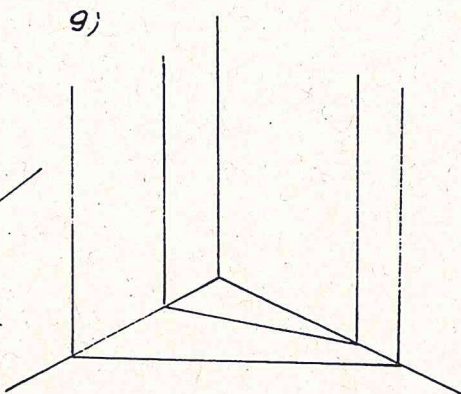

10)

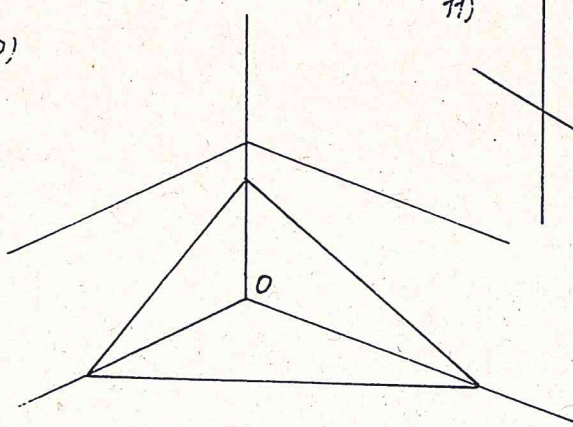

11)<sup>x</sup>

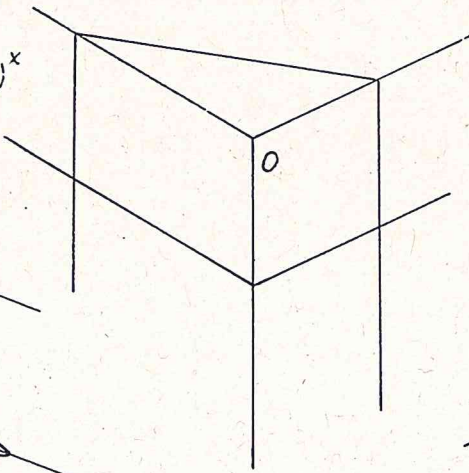

12)

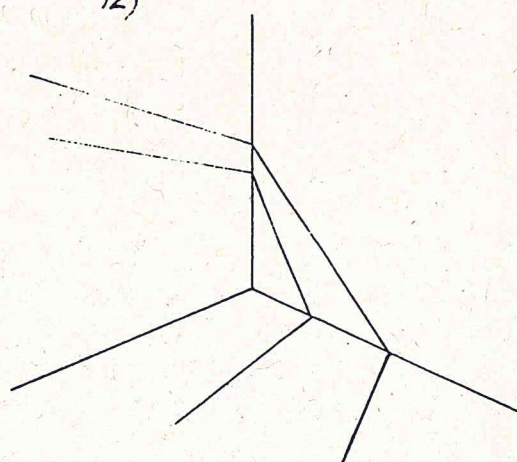

SESTROJTE PRŮSECÍK PŘÍMKY  $a$  S ROVINOU  $\omega$

1)

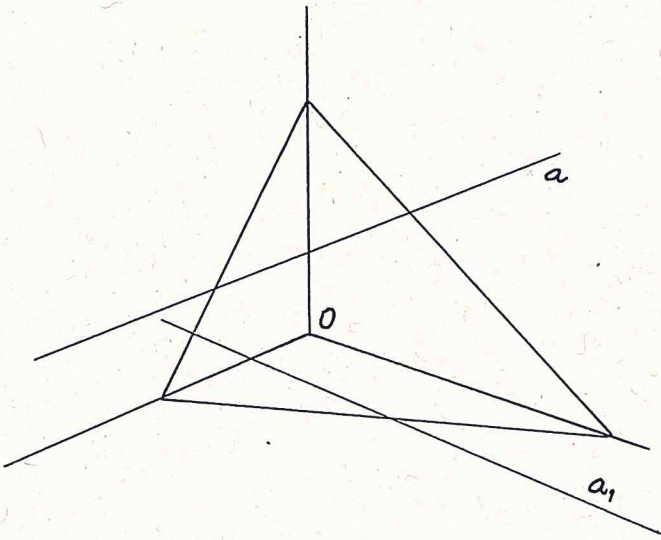

2)

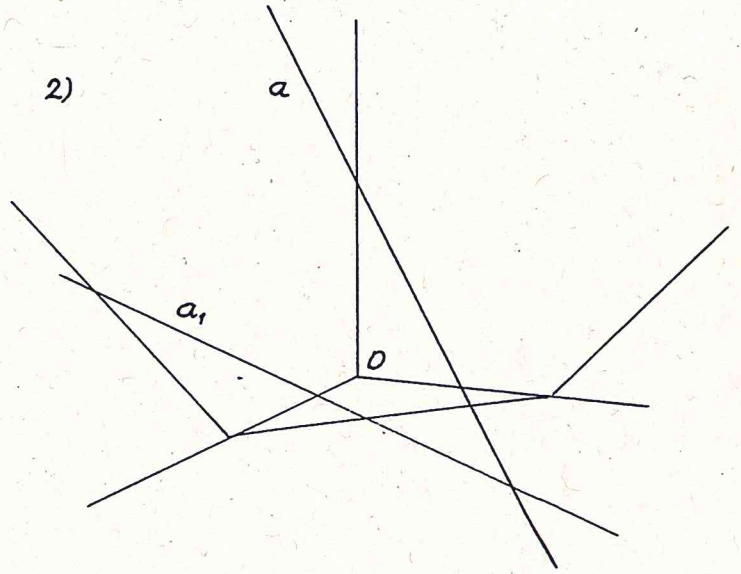

3)<sup>x</sup>

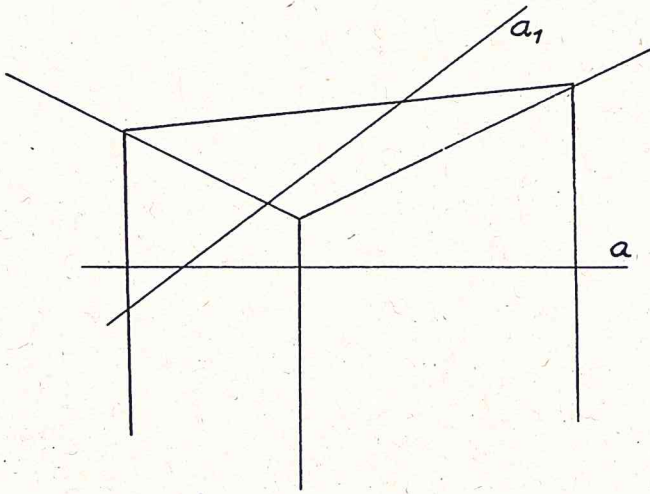

4)

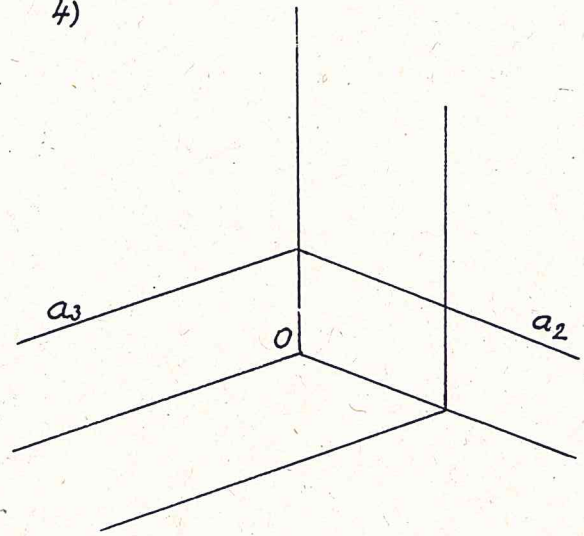

5)<sup>x</sup>

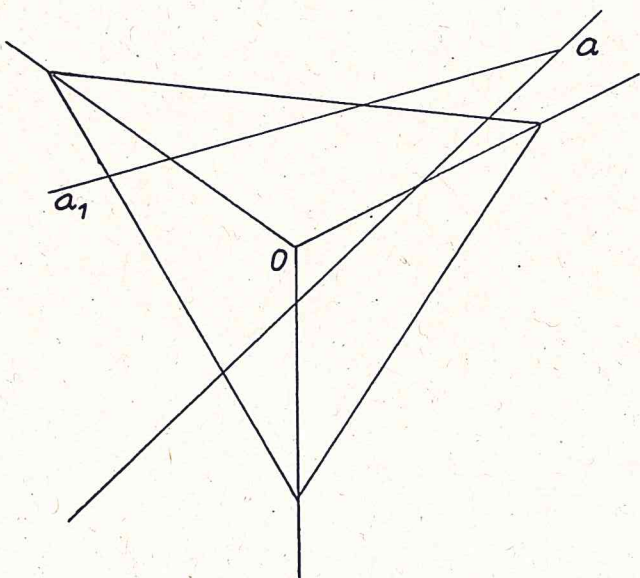

6)<sup>x</sup>

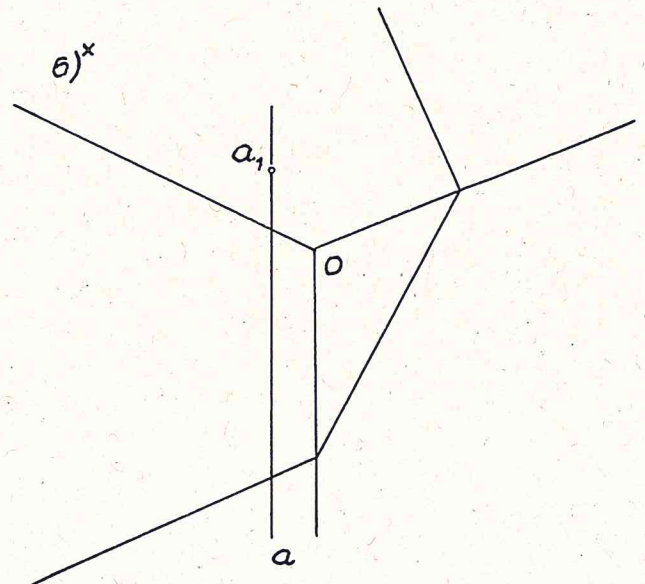

SESTROJTE PRŮSEČÍK PŘÍMKY  $p$  S ROVINOU  $\omega$

1)  $\omega \equiv ab$

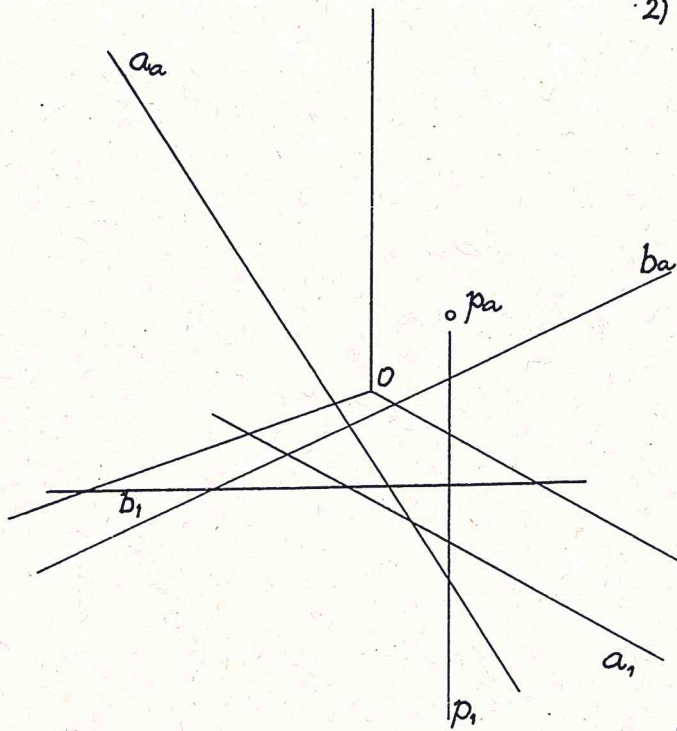

2)  $\omega \equiv ab$

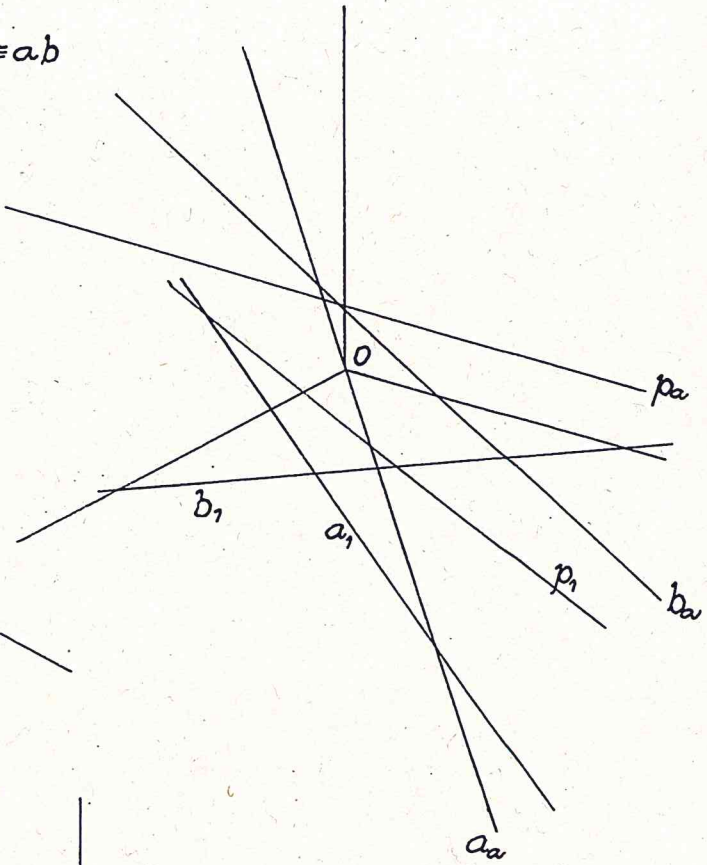

3)

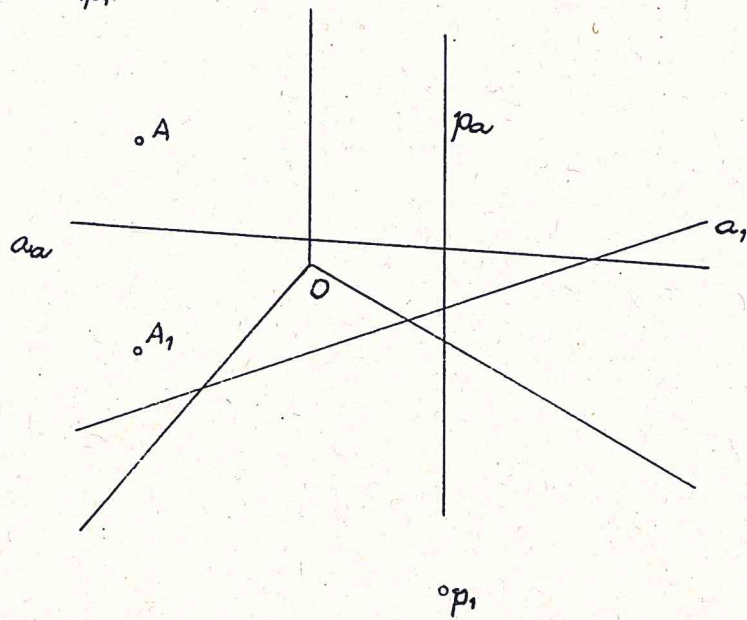

SESTROJTE VZDÁLENOST BODU A OD AXONOMETRICKÉ PRŮMĚTNY

4)

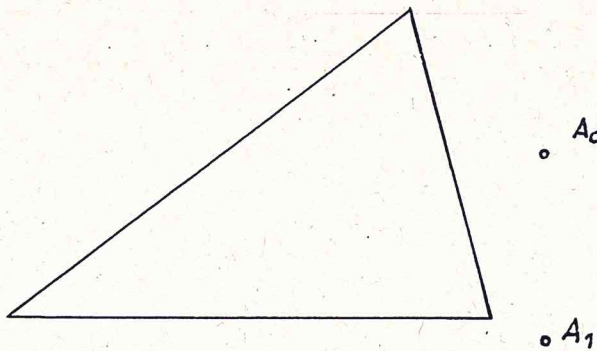

5)

